

Vinyl Handbook

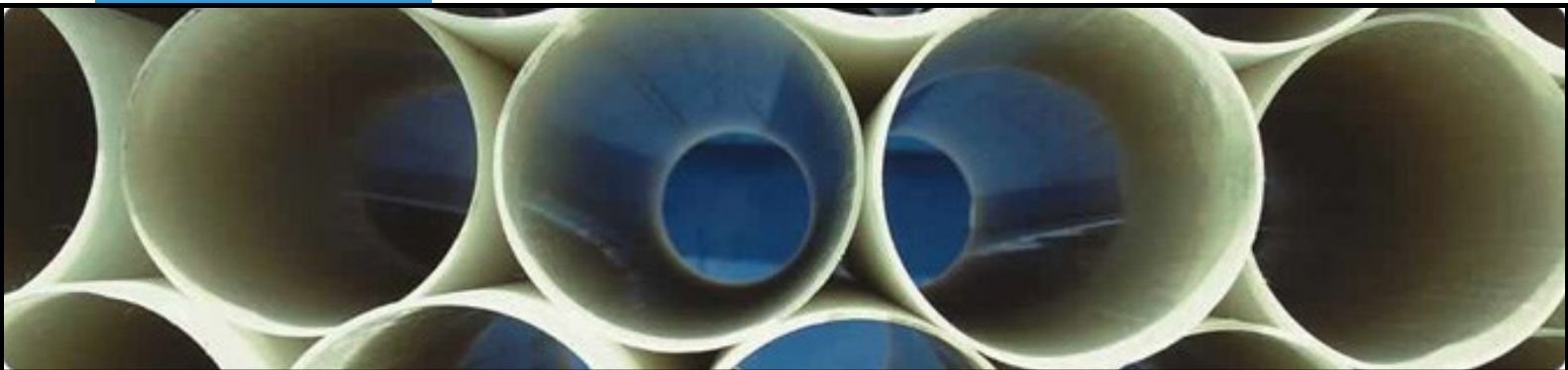

Oxy Vinyls, LP

A subsidiary of Occidental Petroleum Corporation





Occidental Chemical Corporation (OxyChem), including its subsidiary, Oxy Vinyls, LP (OxyVinyls), is a leading North American manufacturer of vinyl resins, chlorine and caustic soda, key building blocks for a variety of indispensable products such as plastics, pharmaceuticals and water treatment chemicals. Other OxyChem products include caustic potash, chlorinated organics, sodium silicates, chlorinated isocyanurates and calcium chloride. For every product it makes, OxyChem's market position is No. 1 or No. 2 in the U.S. Based in Dallas, Texas, the company has manufacturing facilities in the United States, Canada and Chile. OxyChem has been an active participant in the American Chemistry Council's Responsible Care® initiative since its inception in 1988.

Demonstrating their commitment to attaining the highest levels of safety and environmental achievement, Responsible Care companies implement world-class management systems, measure performance based on industry-wide metrics, and are subject to review by independent auditors.

Member of **The Vinyl Institute - The Material for Life** <http://vinylinfo.org/>

Vinyl Handbook © 2014 Occidental Chemical Corporation

Foreword

This handbook outlines recommended methods for handling, preparing and using vinyl resin. It also includes information on the manufacturing, physical properties, safety considerations and bulk handling of vinyl resin. Additional information and contacts can be found at www.oxychem.com.

Important: The information presented herein, while not guaranteed, was prepared by technical personnel and is true and accurate to the best of our knowledge. NO WARRANTY OF MERCHANTABILITY OR OF FITNESS FOR A PARTICULAR PURPOSE, OR WARRANTY OR GUARANTY OF ANY OTHER KIND, EXPRESS OR IMPLIED, IS MADE REGARDING PERFORMANCE, SAFETY, SUITABILITY, STABILITY OR OTHERWISE. This information is not intended to be all-inclusive as to the manner and conditions of use, handling, storage, disposal and other factors that may involve other or additional legal, environmental, safety or performance considerations, and Oxy Vinyls, LP, assumes no liability whatsoever for the use of or reliance upon this information. While our technical personnel will be happy to respond to questions, safe handling and use of the product remains the responsibility of the customer. No suggestions for use are intended as, and nothing herein shall be construed as, a recommendation to infringe any existing patents or to violate any Federal, State, local or foreign laws.



TABLE OF CONTENTS

| | |
|---|-------------------|
| Introduction and Manufacturing Process | 2 |
| Principal Uses of Vinyl | 4 |
| Safety and First Aid | 5 |
| Regulatory Information | 6 |
| Vinyl Resin Property Effects on Rigid and Flexible Applications | 7 |
| Vinyl Additives | 10 |
| Mixing Rigid Vinyl Powder Dryblends | 12 |
| Dryblending of Flexible Vinyl Compounds | 16 |
| Bulk Handling of Vinyl Resin | 19 |
| Silo Inventory: How Product Weight Can be Calculated | 30 |
| Contact Information | Back Cover |

Introduction

Vinyl, also called polyvinyl chloride or PVC, is the world's most versatile plastic since it can be used in both rigid or flexible applications. OxyVinyls' history with vinyl goes back to the 1920's with a scientist named Waldo Semon. Soon after he discovered vinyl could be plasticized, vinyl-based products such as insulated wire, raincoats, and shower curtains hit the market. Vinyl played a key role in the war effort and, in the subsequent decades, vinyl further expanded its uses and became a staple of the construction industry. Today, vinyl is the second largest selling plastic in the world and employs over 100,000 people in the United States alone. Vinyl's low cost, versatility and performance make it the material of choice for industries such as health care, construction, aerospace, and textiles.

Vinyl is made by a series of processing steps that convert common table salt and hydrocarbon-based raw materials (petroleum and natural gas) into this versatile plastic. Vinyl is comprised of over 56% chlorine derived from salt, and so is much less sensitive to fluctuations in the world oil market than most other oil-dependent polymers.

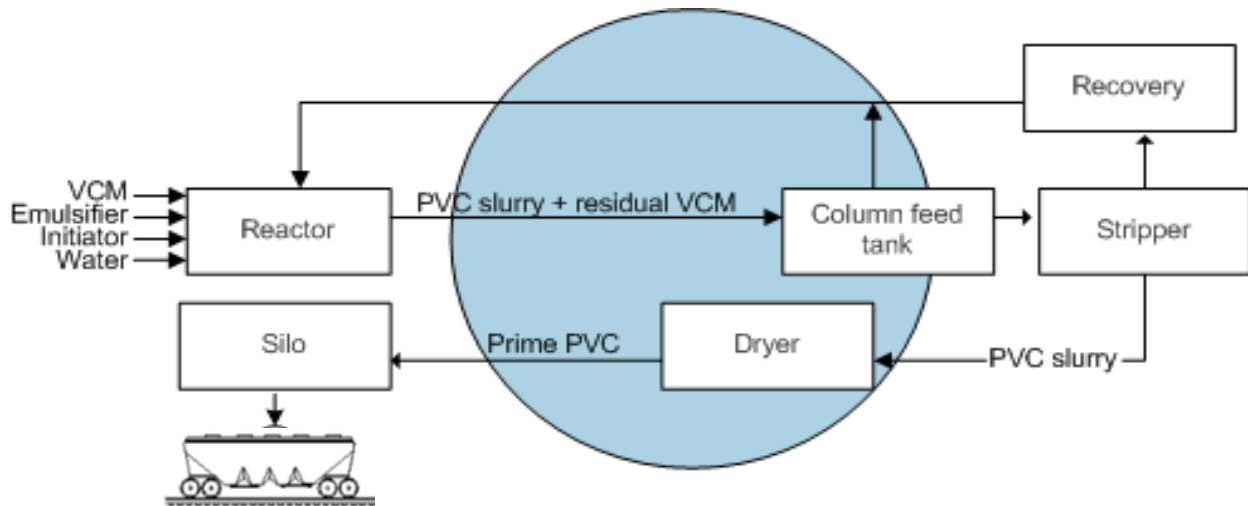

OxyVinyls offers a full product line of vinyl resins suitable for most applications. Our Sales and Technical Service representatives are highly experienced and can help make your vision a reality. Product data sheets are available on our website (www.oxychem.com).

OxyVinyls also maintains the highest quality standards in our resin manufacturing plants, all of which are ISO 9001 certified. Our reliable manufacturing operations lead the industry with an integrated raw material position. This enables OxyVinyls to supply customers consistently, even through major swings in the commodity business cycle.

Our products are manufactured under stringent safety and environmental standards and guidelines. Vinyl products from OxyVinyls are available as dry powder in bulk (railcars and bulk trucks) and packaged in bags. Export shipments can be in bags, bulk bags, or other semi bulk packages.

OxyVinyls Manufacturing Sites

- Niagara Falls, Ontario
- Pedricktown, New Jersey
- Pasadena, Texas
- Deer Park, Texas

OxyVinyls Technical Center

- Avon Lake, Ohio

OxyVinyls Headquarters

- Dallas, Texas

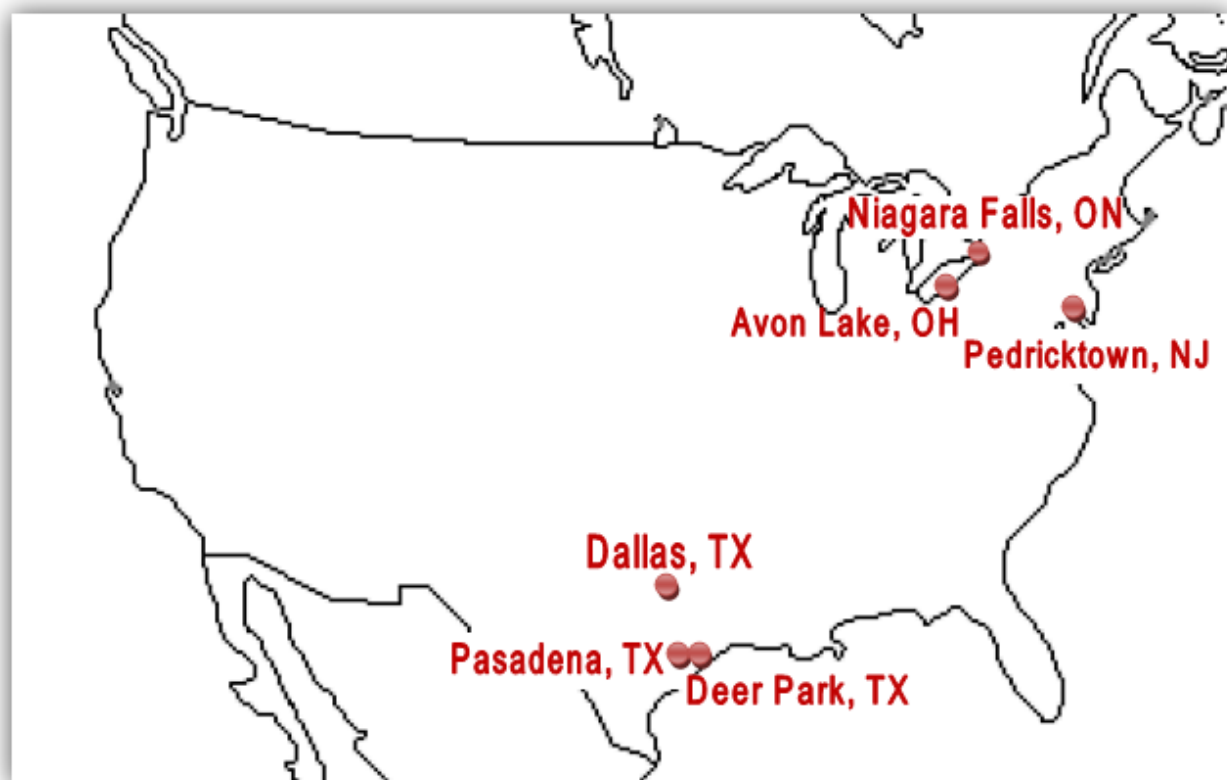



Principal Uses of Vinyl

- Bed Coverings
- Blood Bags
- Bottles
- Calendering
- Ceiling Tiles
- Custom Molding
- Door Panels
- Electric Cables
- Fence and Decking
- Flooring
- Furniture
- Home Playgrounds
- Inhalation Masks
- Insulation
- IV Bags
- Landfill Liners
- Medical Tubing
- Office Supplies
- Packaging
- Performance Sports Surfaces
- Pipe Fittings
- Pipes
- Plastic toys
- Pool Liners
- Roofing
- Seals
- Seat Coverings
- Shoes
- Signs
- Sports Equipment
- Surgical Gloves
- Truck Toppers
- Vinyl Siding
- Wall Coverings
- Windows

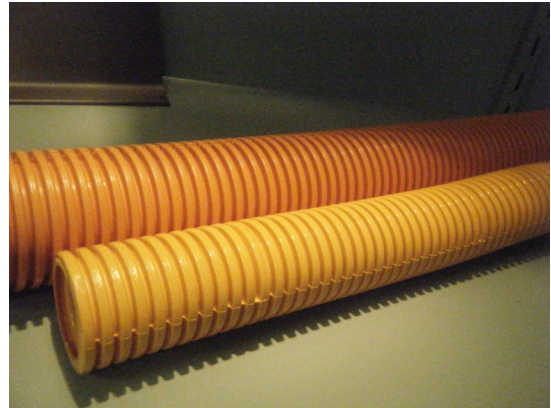

Vinyl Safety and First Aid

Read the SDS before use.

The following is a summary of health and safety information and is not intended to be complete. For complete information, read the current Safety Data Sheet (SDS). To obtain a SDS, contact OxyChem's Health, Environment, Safety, and Security (HESS) Department or go to www.oxychem.com.

Toxicological Information

Acute Toxicity: OxyVinyls resin is non-toxic by oral route and is unlikely to cause skin irritation. VCM (vinyl chloride monomer) is not present at levels that would produce an acute toxic effect.

Chronic Toxicity: Available evidence indicated that pure vinyl resin is not metabolized in mammals. Some studies show pulmonary fibrosis from inhalation of high levels of resin particles. Most resin is large enough in diameter to not be respirable. VCM is not present at levels that would produce chronic toxicity.

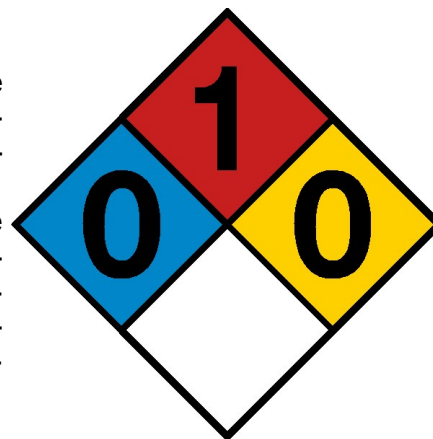

Protection



Personnel

Vinyl resin is a solid, white granular powder. While the resin has little toxicity, fumes produced during processing may irritate respiratory tract, skin and eyes. Personal protective equipment (PPE) is recommended. PPE recommended is: Safety glasses or goggles, chemical resistant gloves, suitable protective clothing, and under certain circumstances an approved respirator with dust, mist and fume filters.

First Aid

Inhalation: If adverse effects occur, remove to uncontaminated area. If irritation occurs, *get medical attention*.

Skin Contact: Wash contaminated areas with soap and water. If irritation occurs, *get medical attention*.

Eye Contact: Flush eyes with plenty of water for at least 15 minutes. If irritation occurs, *get medical attention*.

Ingestion: No hazard expected. If large amounts are ingested, *get medical attention*.



RESPONSIBLE CARE[®]
OUR COMMITMENT TO SUSTAINABILITY



Regulatory Information

Read the SDS before use.

The following summary of regulatory information is not intended to be complete. For complete information, read the current Safety Data Sheet (SDS). To obtain a SDS, contact OxyChem's HESS Department or go to www.oxychem.com.

OSHA Regulatory Status: This material is considered hazardous by the OSHA Hazard Communication Standard (29 CFR 1910.1200)

CERCLA Sections 102a-103 Hazardous Substances (40 CFR 302.4): If a release is reportable under CERCLA section 103, notify the state emergency response commission and local emergency planning committee. In addition, notify the National Response Center at (800) 424-8802 or (202) 426-2675.

| Hazardous Component | CERCLA Reportable Quantities: |
|---------------------|-------------------------------|
| Vinyl chloride | 1 lb (final RQ) |

OSHA Specifically Regulated Substances: OSHA 29 CFR 1910.1017 (vinyl chloride); The U.S. Department of Labor, Occupational Safety and Health Administration specifically regulates manufacturing, handling and processing of vinyl resin. Such regulations have been published at 29 CFR 1910.1017. It is necessary that handlers and processors of vinyl be familiar with these regulations.





Vinyl Resin Property Effects on Rigid & Flexible Applications

OxyVinyls suspension grade resins are used in a wide range of rigid and flexible applications. The physical properties described below determine many of the important bulk handling, processing, health/safety and end use characteristics a vinyl customer requires.

Inherent Viscosity (IV)

A solution viscosity test is used by OxyVinyls to measure the Inherent Viscosity of our resins. IV value characterizes the average molecular weight of the vinyl resin chains. The larger the number, the higher the average molecular weight of the resin. Molecular weight has a major influence on two important resin characteristics: physical properties and ease of processing. As molecular weight increases, attainable physical properties tend to increase. In contrast, processability and melt flow are usually enhanced as molecular weight decreases. A balance between vinyl's properties and the type of process is an important consideration.

Apparent Bulk Density (ABD)

Apparent bulk density is the amount a given volume of resin will weigh without compaction. The larger the value, the denser the product. It is usually shown in units of g/ml (or g/cc), but is easily converted into English lbs/ft³. ABD is an important characteristic that can influence production rate, melt fusion, and dimensional stability in an extrusion process. It is also used for calculating the amount of resin inventoried within a silo. ABD properties can be especially sensitive to static build-up on the resin's surface, effectively reducing density.



Resin Color (L*, a*, b*)

Resin color is displayed by three color coordinates: "L*" (lightness), "a*" value (green-red) and "b*" value (blue-yellow). Transparent and light colored applications are normally the most sensitive to resin color. Our labs utilize the CIELAB Illuminant C and 2 Degree Observer Specular Included standard to quantify the color of our products.

Heat Loss (HL) or Volatiles

Heat loss (also known as Volatiles) is the amount of moisture that can be removed from resin when heated. Most production resins are in the 0.1% range when delivered. If the heat loss is too low, static build-up on the resin surface becomes a concern, creating flow issues. If heat loss is too high, resin flow and processing issues may be encountered. Some customer may have difficulty removing the excess steam that is produced in the melt phase of their operation. This can trap gas bubbles within the melt which can undermine the impact strength or create appearance problems in the end product.

Flow Time (FT)

Flow time is the measure of time required for a given amount of resin to flow through a standard metal funnel. The longer the time, the slower the resin flowed through the device. Typically, vinyl resin FT values range between 6 and 14 seconds. Flow usually indicates how well a resin can be bulk handled and its resistance to bridging in the feed hopper. Depending on the dryblend recipe, it may also determine how well the material will fill the screw flights of an extruder/molding machine. Like ABD, flow time is sensitive to static build-up which will increase the amount of time required for processing.

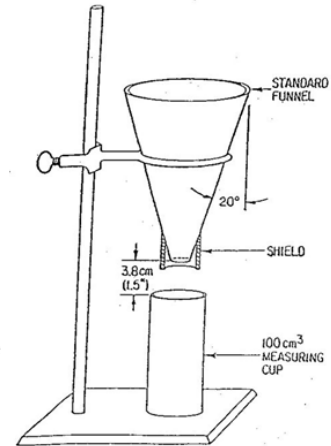

Particle Size (PS)

Particle size and distribution are important properties in both bulk handling and processing. PS results are shown as the percent resin weight retained on a set of US Standard Sieves ranging from #40 to #200. The coarser resin remains on the #40 and #60 sieves, while finer particles are retained or pass through the #200 mesh.

Elevated levels at either extreme can create issues for the customer. Due to their larger size, coarse particles can be difficult to break down, especially in rigid, low shear processes. These oversize materials can create surface appearance defects (gels) in extruded parts. In contrast, excessive fine particles can cause dust and flow issues, and are especially susceptible to static build-up.

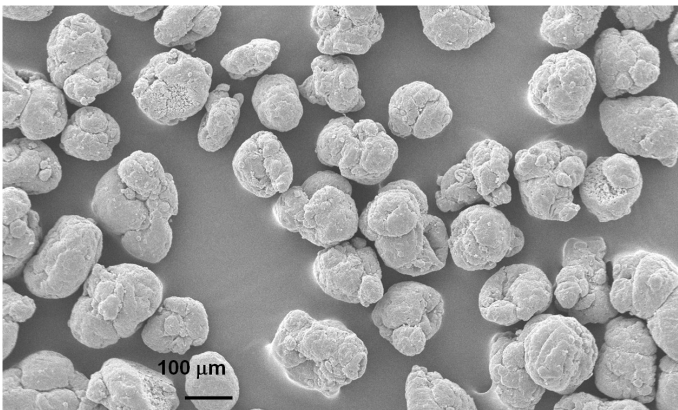

Contamination

Contamination represents darker colored vinyl particles created during the RVCM stripping or drying process. Results are provided in particles per unit weight of resin. Applications most sensitive to these particles include transparent, light colors and thinner films.

Residual Vinyl Chloride Monomer (RVCM)

RVCM is the amount of unpolymerized monomer remaining in the vinyl polymer after the polymerization reaction is completed. The amount of monomer remaining inside the resin is extremely low. RVCM is normally shown in parts per million (ppm). OxyVinyls resins consistently meet industry and government standards.

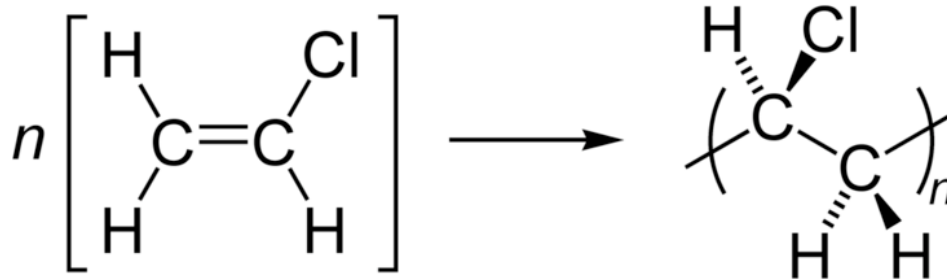

Gels

Gels in rigid applications are resin particles that break down or melt at a slower rate than surrounding material. Film grade resins, our highest quality product, contain a lower number of these particles per volume. Applications that are transparent, thin, or for which surface appearance is critical are especially sensitive to gel content.

In flexible applications, gels can be due to the presence of either ppm-quantities of resin grains that are of higher molecular weight than the main resin being used in the compound, or they can also be due to the presence of resin grains that for some reason (such as slow-absorbing resin particles or raw resin leaking into finished dryblend) contain lower concentrations of plasticizer than the grains of the main dryblend material.

Porosity

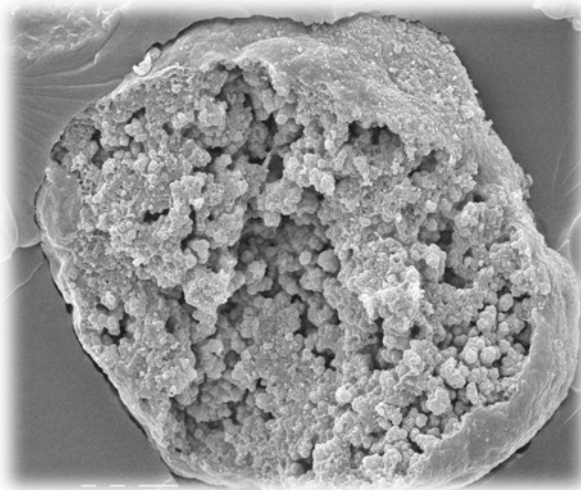

The volume of the air space inside the resin grains surrounding the primary resin particles is referred to as porosity. This quantity, typically expressed as cubic centimeters of air volume per gram of resin, is the volume in the resin grains into which plasticizer flows when it is first added to the resin being blended. The term “porosity” as used in North America is very similar to the property “Cold Plasticizer Absorption” which is a term frequently used in Europe. For additional information, see the section, “Dryblending of Flexible Vinyl Resins.”

Vinyl Additives

For vinyl to be useful, additives are required to turn the resin into a finished product. Listed below are some common types of additives utilized in vinyl formulation.

Thermal Stabilizers

Vinyl is a heat and light sensitive polymer. The addition of the thermal stabilizer is critical when a compound is subjected to heat, melt processed, and formed into a product. The function of the stabilizer is to delay the degradation that occurs at elevated temperatures. Vinyl degrades by dehydrochlorination and oxidation reactions. The stabilizer functions by absorbing hydrogen chloride, displacing active chloride atoms, free radical scavenging, disruption of double bond formation, and deactivation of degradation by-products, peroxide decomposition and ultraviolet energy absorption.



Processing Aids

A processing aid can reduce or increase melt viscosity, increase shear heating/work level during processing, and reduce uneven die flow. It can also increase the melt's hot strength for downstream sizing and improved cell structure in a foam process.

Plasticizer

Plasticizers are materials that are added to PVC to make the materials flexible. They function by dissolving into the amorphous regions of the polymer, effectively lowering the glass transition of the amorphous portion of the chains to below the temperatures at which the materials will be used (for example, room temperature or lower).

Impact Modifiers

Certain applications require higher impact strength than vinyl would otherwise provide. Specific families of impact modifiers can enhance vinyl's outdoor weatherability, chemical resistance, flame/smoke and tensile strength performance.



Blowing Agents

Chemical blowing agents are designed to produce a cellular structure within vinyl's polymer melt. These additives affect the melt density, increasing vinyl's natural thermal insulation and sound deadening capability.

Lubricants

Lubricants influence the melting point, internal shear, melt viscosity, and metal release characteristics of a vinyl compound in a process. There are three types of lubricants determined by their effect on the melt:



External Lubricants—Delay fusion of the melt and provide metal release by lubricating between the compound and the hot metal processing surfaces.

Internal Lubricants—Provide lubrication at the molecular level, reducing internal shear and the melt viscosity of the compound.

External/Internal Lubricants—These materials provide both external and internal lubrication characteristics, depending on the combination of chemical groups contained.

Alloying Polymers

Alloying polymers with vinyl permits a potentially wider range of property balance depending on type of polymer added. Some of the changes could be: viscosity, thermal & chemical resistance, impact resistance, weatherability, and processability.

Pigments

There are three main reasons to use pigments in PVC compounding: to achieve opacity, UV protection, and to achieve a given color.

Fillers

There are many types of fillers which can be used with vinyl including: metal carbonates and silicates, gypsum, clay, alum, barytes and wood flour. The most common are metal carbonates, mainly calcium carbonate and clay. Calcium carbonate is available in ground and precipitated grades with a range of particle sizes. As a general rule, the finer the filler grade, the better the impact performance of the finished product.



UV Stabilizer

UV stabilizers are added to vinyl to reduce degradation of the vinyl application due to UV radiation. These stabilizers reduce the penetration and absorption of the UV rays, thus increasing the weathering characteristics of the vinyl product.

Mixing Rigid Vinyl Powder Dryblends

Mixer and Cooler

The high intensity mixer and cooler units are the heart of a vinyl processor's blending system. A vinyl formulation typically contains numerous ingredients in addition to the vinyl resin. A mixer's function is to disperse and distribute a range of types/particle size materials as uniformly as the pressures of cycle time and productivity permit. Batch consistency is critical to the downstream transfer, process, and, ultimately, end-product performance.

After the blend has cooled, the powder compound should be screened to remove mixer blend flakes that tend to build up on the walls, baffle, and blades. Normally a #10 screen mesh for pipe and #30 mesh for siding are sufficient. If retained, these flakes can cause both surface appearance imperfections and undermine product properties.

Mixing Procedures

The procedures described below are basic and have successfully evolved over many years of trial and error. They should be considered starting points in developing a process that is optimized for your specific operation and recipes.



Photo courtesy of Zeppelin®

Procedure A

1. Start high-intensity mixer at low speed and add resin.
2. Shift to high speed and add stabilizer.
3. Add all dry ingredients.
4. Mix until temperature reaches 88°C (190°F), then drop into cooler.
5. Cool at 43°C (110°F).

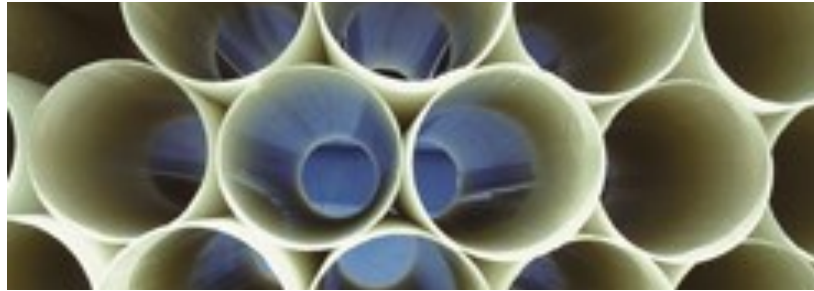

Procedure

B (double

batching)

Procedures A and B have proven to be very successful over the years. They have been followed by siding, pipe and cellular vinyl processors with excellent extrusion quality. Procedure B was developed to optimize productivity. It increases mixer capacity by 150 to 175% with minimal increase in cycle time. This is called a one-to-one dilution or double batching. A mix at this level of dilution extrudes very well, but ratios above 1.2 to 1 have experienced consistency problems.

Example: Your entire cooled powder blend consists of:

- 500 lbs PVC resin
- 6 lbs Liquid tin stabilizer
- 50 lbs Dry additives (fillers, lubricants, impact modifier, & pigments)
- 556 lbs Total

High-intensity mixer & cooler procedure:

1. Start mixer at low speed and add 250 lbs of PVC resin
2. Shift to high speed and add all 6 lbs of stabilizer
3. Add all 50 lbs of dry additives
4. Mix until the dry blend reaches 88°C (190 F), then drop into cooler.
5. Add the remaining 250 lbs of PVC resin to the cooler.
6. Mix and cool the powder blend to 43°C (110 F) or lower.
7. Transfer or pack as usual.

Note: To prevent metal graying of siding powder compound, the titanium dioxide should be held out until 5-6°C (10°F) before dropping from the mixer.

Problems

The three most common problems encountered in mixing rigid vinyl are:

1. excessive amperage on the mixer,
2. no vortex, and
3. fluffy powder.

High Mixer Amps

Usually caused by overloading the mixer with resin or other ingredients, this problem can be corrected by changing the batch size.

Poor Vortex

High batch size may also prevent a vortex from forming. No vortex usually indicates poor mixing, which can cause the extruder amps to vary. Inconsistent extrusion amps may affect impact properties and dimensional tolerances of the end products. Maintaining a deep vortex in the powder can correct these problems.

Fluffy Powder

Dryblends displaying this characteristic have frequently been affected by static build-up. The static may have been acquired on the resin during conveyance from the bulk car, mixer or the silo system. Many times, the powder will appear wet and “snowballs” can be formed. When exposed to steam, the powder will change from “flour” to “sugar” in texture again.



Static retention on resin or blended compound is highly dependent upon the amount of moisture present. Consequently, it is more of a problem during the winter or in arid locations, when relative humidity is very low.

One practical technique devised to address this problem is water addition to the mixer. By adding a small amount of water to the mixer during blending (8 to 30 oz per 600 lb batch), the amount of static can be dramatically reduced. The water is preferably added after the stabilizer addition and the mixture is allowed to proceed as normal. A portion of the water will vaporize into steam, immediately reducing the static within the blender. The remaining water helps to dissipate any static generated as the powder is cooled and transferred to the day bins. Mixing procedures that utilize a high drop temperature tend to aggravate static problems.



Please note: Some Oxy resins are anti-stat treated to inhibit static build-up. However, mixing over 77°C (170°F) can destroy the anti-static properties of these resins. To retain these properties while still achieving good mixing, Procedure C should be followed.

Procedure C (Modified double batching)

By following this procedure, the antistatic properties of only half the dry blend's resin will be broken down. The remaining half of the resin retains enough of these properties to diminish static problems downstream.

Example: Your entire cooled powder blend consists of:

- 500 lbs PVC resin
- 6 lbs Liquid tin stabilizer
- 50 lbs Dry additives (fillers, lubricants, impact modifier, & pigments)
- 556 lbs Total

High-intensity mixer & cooler procedure:

1. Start mixer at low speed and add 250 lbs of PVC resin
2. Shift to high speed and add all 6 lbs of stabilizer
3. Add all 50 lbs of dry additives
4. Mix until the dry blend reaches 88°C (190°F), then drop into cooler.
5. Cool the dry blend to 77°C (170°F) or below, then add the remaining 250 lbs of PVC resin to the cooler.
6. Mix and cool the powder blend to 43°C (110°F) or lower.
7. Transfer or pack as usual.

Note: To prevent metal graying of siding powder compound, the titanium dioxide should be held out until 5-6°C (10°F) before dropping from the mixer.

For additional information, OxyVinyls' Technical Service Group is available to provide guidance.



Dryblending of Flexible Vinyl Compounds

The optimum process for dryblending flexible vinyl compounds in different applications depends on many factors including: available mixing equipment, downstream processes, the compounds being produced, and desired balances between quality and productivity. The information below provides insight into these factors. In addition, the Technical Service Group at OxyVinyls is available to discuss various aspects of this subject, and there are many excellent references that go into more detail.

Addition of Plasticizer

As the first step in producing a flexible dryblend, plasticizer is added to the resin in appropriate mixing equipment. It is important to distribute the plasticizer uniformly onto the vinyl powder. In equipment like a ribbon blender, the plasticizer should be sprayed uniformly onto the mixing resin, keeping the plasticizer directed away from the heated walls of the blender. In high speed mixers, the plasticizer should be added into the rolling vortex, again keeping the plasticizer stream off the walls and making sure that the blender is set up to provide a continuously turning vortex that is homogeneous from top to bottom.

As soon as the plasticizer is added to the resin, a significant portion of it very quickly migrates inside the resin grains to occupy the very small air spaces surrounding the 1 μ primary resin particles inside the main resin grains. Photos showing both typical 150 μ resin grains and the primary particles and air spaces within the grains are shown below and on the following page.

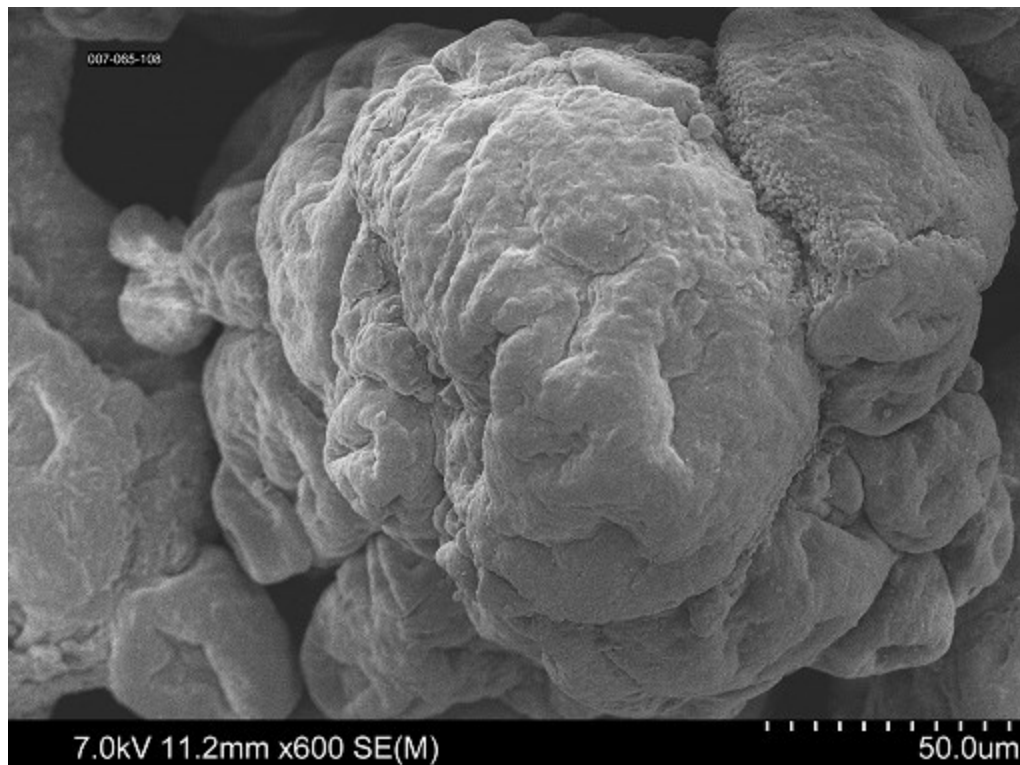

With typical plasticizers such as phthalates, trimellitates, adipates, etc., the migration of the plasticizer into the grains happens very quickly, within 2 to 3 seconds, even at room temperature. With polymeric plasticizers and long-chain plasticizers, the migration is somewhat slower, but it still happens quickly.

Plasticizer Temperature

To produce the highest-quality dryblends, the plasticizer should be added to the resin at fairly low temperatures. A temperature of 43°C (110°F) is commonly recommended in that this temperature is essentially achievable year-round, even in the summer. Temperatures even lower than this, for example resin coming from a cold silo in winter, are not detrimental. In cases where faster cycle times are desired, the plasticizer can be pre-heated before being added to the mixer. Doing this shortens cycle times, since the blend reaches dryup temperatures more quickly, but for the most critical cases, this procedure results in slightly lower quality dryblends.

As soon as the plasticizer is added to the mixer and throughout the initial heating stage, the vinyl resin-plasticizer mixture consists of essentially unplasticized primary resin grains which are in close proximity to the plasticizer that migrated inside the grain and extra plasticizer, which remains around the outsides of the resin grains, resulting in a somewhat sticky (“wet”) feel to the mixture.

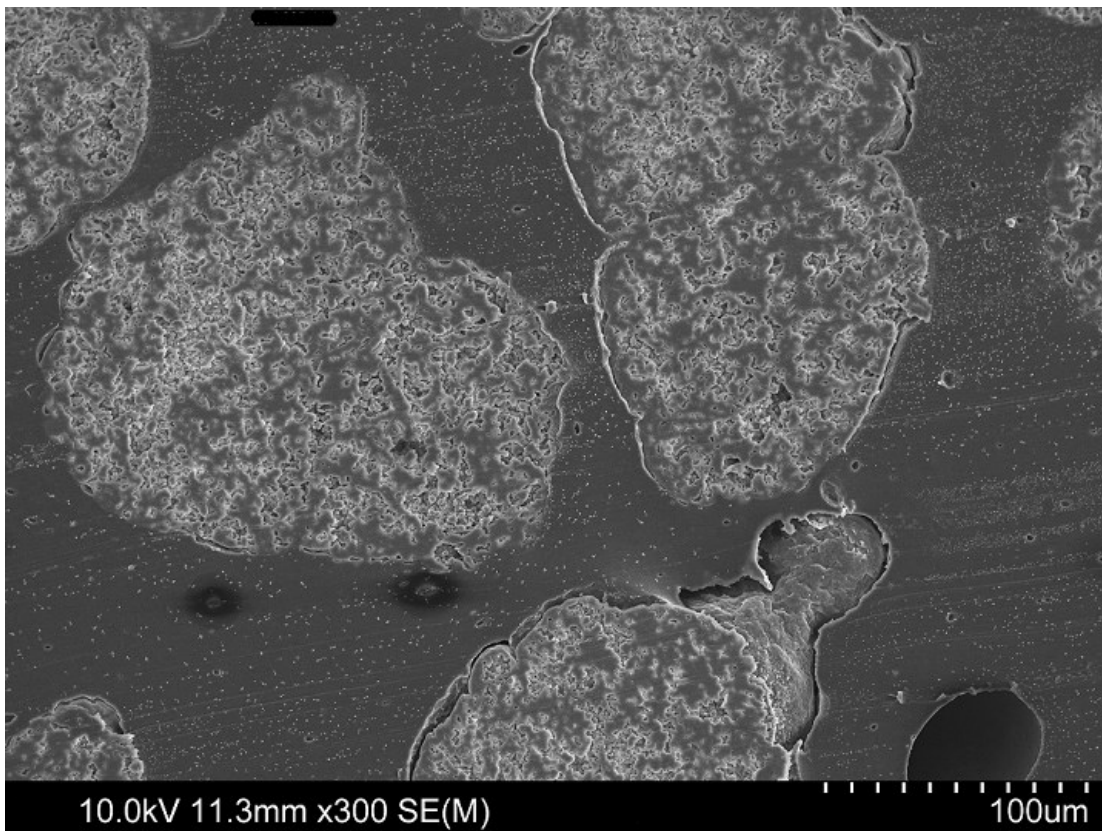

Creating Dryblend

As the temperature of the mixture increases, approaching 85°C (185°F), both the molecules of plasticizer and the chains of the polymer begin moving (vibrating) faster and faster. As this movement becomes more vigorous, the plasticizer begins to dissolve into the unplasticized regions of the vinyl primary particles, creating plasticized vinyl. As this process continues, most of the plasticizer is no longer present on the outsides of the vinyl grains and it becomes uniformly distributed within the vinyl grains. At the same time, the blend which was initially sticky because of the free plasticizer that was present on the surfaces of the particles at lower temperatures now becomes dry and free-flowing again. This part of the process is known as dryup.



As the mixture becomes dry, the easier flow is readily obvious from curves of the mixer amps with time (and temperature), and the finished dryblend can either be dropped to a cooler and transferred to storage, or it can be used immediately in the next step such as being fed directly into a compounding extruder, tubing extruder, calender, etc.

Finished Dryblend Temperature

The exact temperature at which the blend should be considered finished and ready to drop will depend on many of the factors mentioned earlier. For example, trimellitate formulations often require 5° to 10°C (41° to 50°F) higher temperatures to achieve dry-up than common phthalate plasticizers. Also, especially in screws that are somewhat feed-limited, a dryblend that is still slightly wet, such that one can form a “snowball” when pressing with ones hand, will feed faster in the extruder.

For additional information, OxyVinyls’ Technical Service Group is available to provide guidance.



Bulk Handling of Vinyl Resin

Several factors should be considered when designing a bulk handling system. The equipment investment required to install a facility for handling bulk resins can be high. Processors usually require a volume of 3 to 4 million pounds per year to justify the cost. For those at or above this volume, significant savings can be gained by purchasing OxyVinyls resin in bulk.

Potential Savings Realized

- **Lower Product Cost** - Direct cost savings can be realized. Bulk railcar and bulk truck purchases are normally lower than bag pricing.
- **Reduced Contamination** - The cost associated with bag contamination (paper, cardboard, skid debris, etc.) will be eliminated.
- **Lower Labor Cost** - A fully automatic receiving, storage, and in-plant delivery system can be operated by one person.
- **Floor Space Savings** - Warehouse space normally assigned to bag, Gaylord, and super sack storage can be used for finished product storage or production space.
- **Automated Integration with Production** - The entire process of unloading, storage, delivery, and metering of material into production equipment will eliminate costly distribution problems and delays.
- **Safety and Housekeeping** - Self-cleaning, non-contaminating, totally enclosed dust collection and recovery systems can be employed for a cleaner plant.



Pneu-

matic

Photo courtesy of Ee-Jay Motor Transports, Inc.

Bulk Material Handling Systems

Resin in dry bulk is classed as a free-flowing material. Reliable systems can be designed and are available from a number of suppliers for railcar and truck, bulk unloading and in-plant handling. All bulk material handling systems utilize air to convey individual particles of plastic material in a given volume and simultaneously move the resin and air at high velocity through a piping system. Described are three types of systems available for handling vinyl resin in a pneumatic conveying system.

Vacuum System

One choice for conveying vinyl resin from several places to a single point is the negative pressure conveying system (vacuum system, Figure 1), which uses a high velocity air stream. The ambient air enters the suction side of a positive displacement blower. The pulled air passes through material and draws it into the air stream. The material and air is separated by a filter receiver at the terminal point of the system. A rotary valve is used to meter the material out of the receiver into the silo, hopper, etc.

Figure 1
Negative Pressure Conveying System

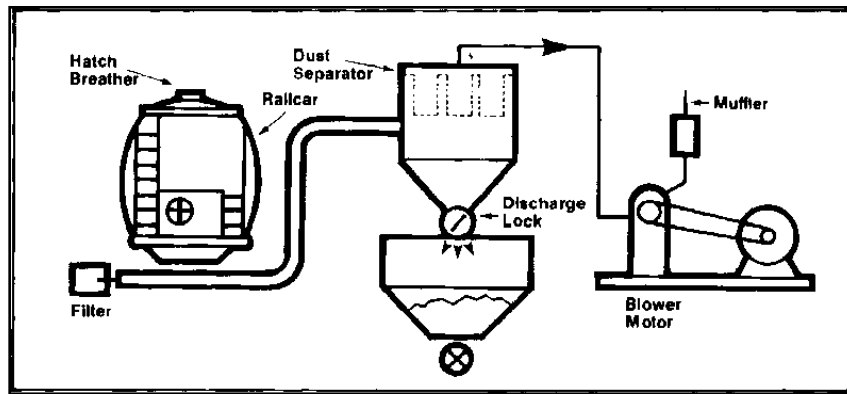

Pressure System

Another choice for conveying vinyl resin is the pressure system (or positive pressure, Figure 2), which uses compressed air. The product is introduced to air through a sealing device on the discharge side of a positive displacement blower. The air and product are moved by the action of pressure to a vented filter receiving bin.

Figure 2
Positive Pressure Conveying System

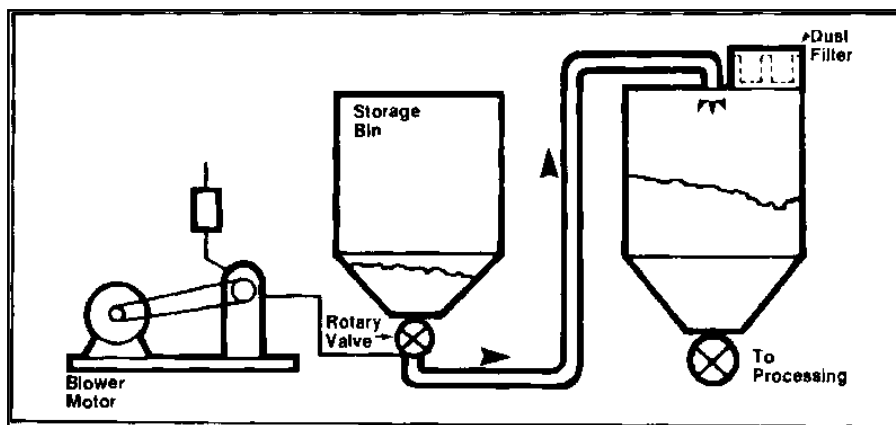
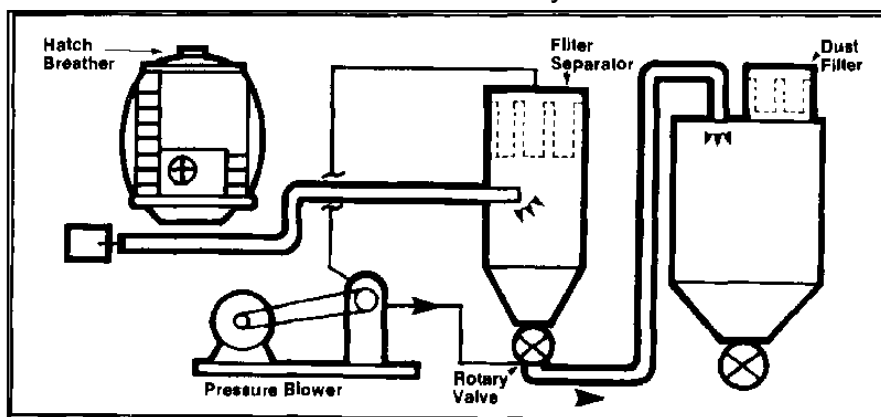

Figure 3
Vacuum/Pressure System



Vacuum/Pressure Systems

A combination of both technologies described previously. (Figure 3)

Generally, the positive pressure conveying system is the most efficient. More pounds of material per pound of air can be handled due to the higher air density system.

Reliable dilute phase bulk systems for vinyl resin should meet the following criteria:

1. Linear velocity of 5000 ft/min average.
2. Air flow to filter area ratio should be 5.5 SCFM/ft².
3. Hopper cone angle is recommended to be 60°, but not below 45°.
4. Bulk density of the material will be 30-40 lbs/ft³.
5. Filter type should be pulse jet, continuous cleaning.
6. Storage capacity should be two times bulk container capacity.
7. Air sources are positive displacement blowers (oil free).
8. Storage silos should be bolted or welded: aluminum, epoxy coated carbon, or stainless steel depending on the corrosiveness of the local environment.
9. Level switches should be paddle wheels or capacitance.
10. Conveying lines should be light weight (Schedule 5 or 10) aluminum or stainless steel.
11. Elbows should be very long sweeping stainless steel.
12. Rotary valves should be stainless steel.
13. Dust filter frames should be epoxy-coated carbon steel, or stainless steel.
14. Filter bags should be made from polyester or other compatible materials.

Note: Rotary valves must be monitored for preventive maintenance. The close tolerances must be maintained or resin particles can get between the two surfaces and build up excessive frictional heat that will cause the resin to fuse. This milled resin can flake off into the product stream and cause plugging of the bulk system.

Some companies use fluidized “pressure vessel” conveying systems that have no rotating parts in the product stream. Following are other advantages offered by pressure vessel conveying:

1. Two or more weighed ingredients in the same vessel attain some mixing action.
2. Flexibility to convey two dissimilar materials in separate batches without having to change rotary lock gearing or speed.
3. Conveying at higher pressures, which use smaller lines and denser flow patterns than rotary locks.

Figures 4, 5 and 6 illustrate pressure vessel conveying and its adaptability to the accepted pressure and combination pneumatic conveying system.

Figure 4
Vacuum/Pressure System

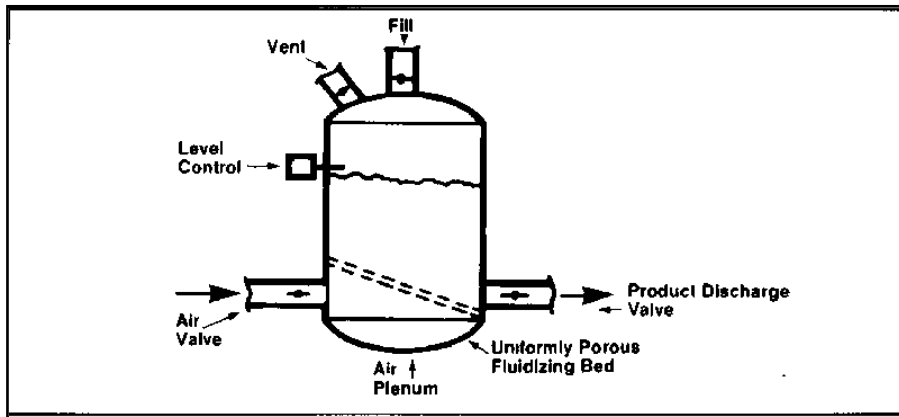

Figure 5
Combination System

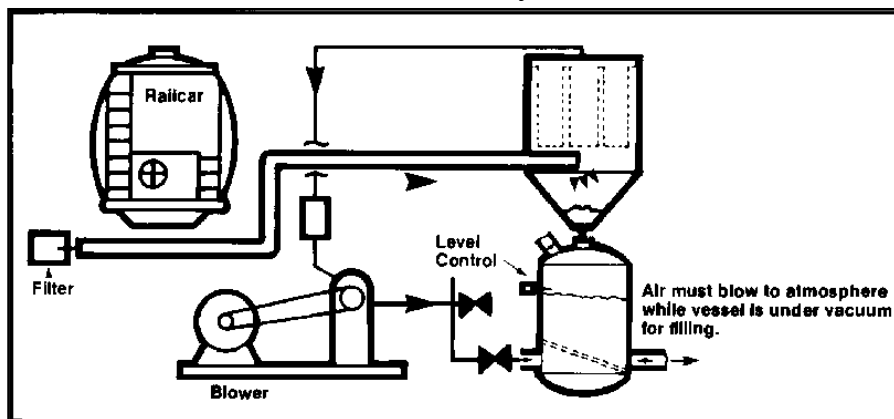
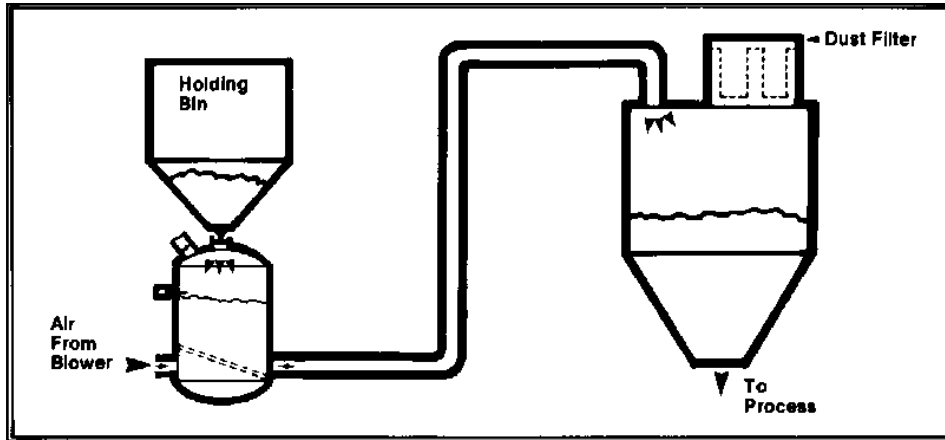

Figure 6
Complete Vacuum/Pressure System Using Pressure Vessel



Operation

Vessel is filled to level control or weight limit. Fill and vent valves close and the vessel is pressurized. Material and air flow to receiver.

Bulk Shipping Equipment

OxyVinyls offers bulk shipments of both general purpose and specialty film grade resin in both railcars and trucks. The railcars are specifically designed for pneumatic bulk unloading; interiors are lined with a special non-toxic, non-contaminating material to protect the vinyl products. Rigorous and exacting standards are maintained for inspection, cleaning and loading of each car.

Figure 7
Resin/Powder Bulk Handling System - Powder Compounds

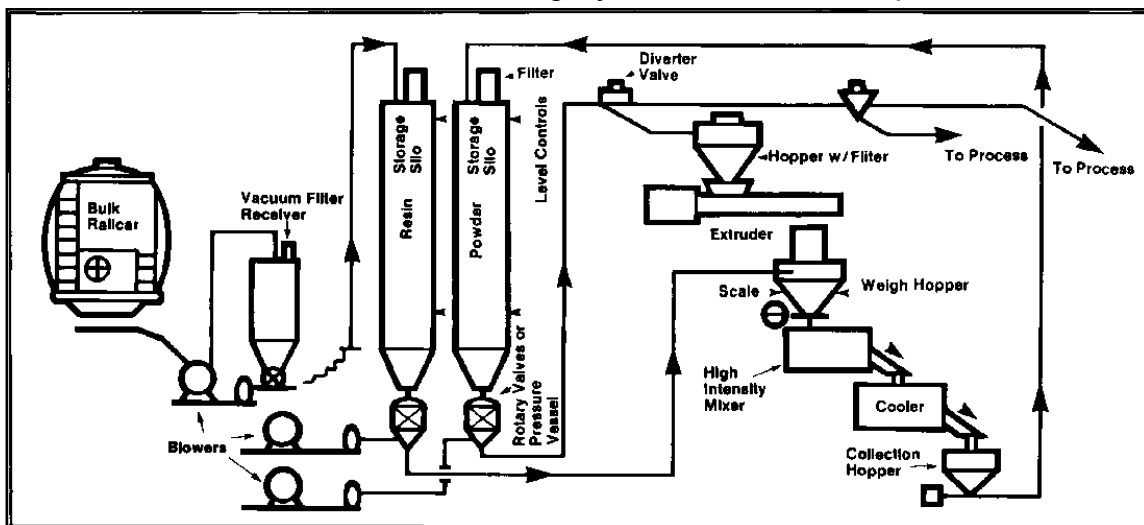

Figure 8
Resin/Powder Bulk Handling System - Cube Compounds

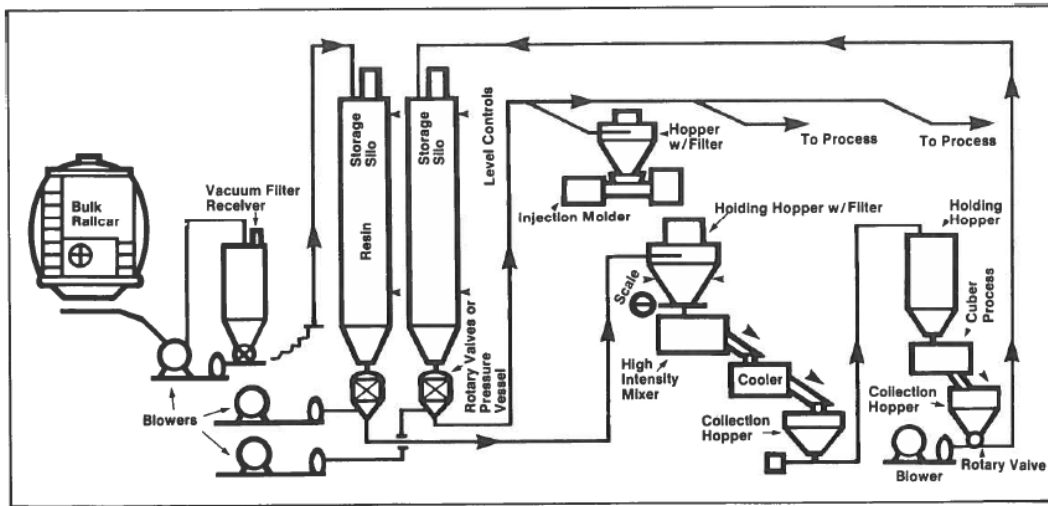

Figure 9

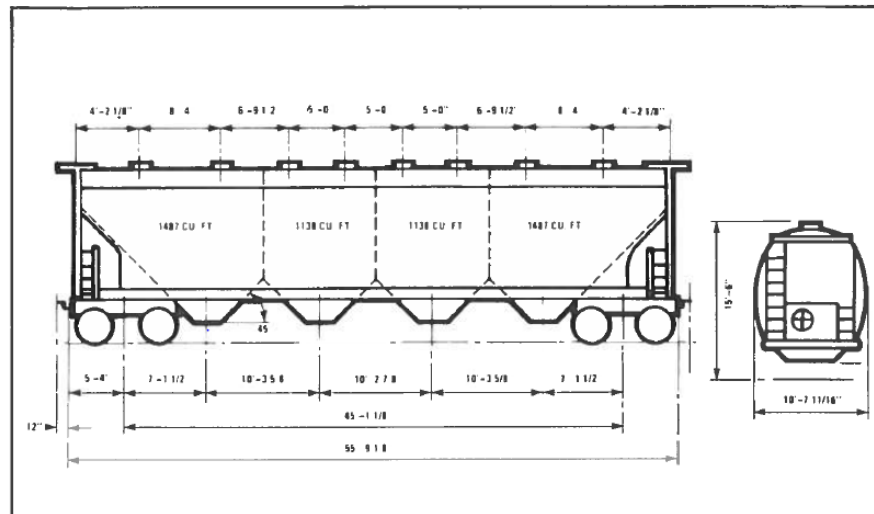

Diagram courtesy of ACF Industries Inc.

Preparatory Steps for Unloading

1. Open at least one top hatch on the hopper car being unloaded to avoid risk of collapsing the bulkheads. A filter must be applied to the open hatches to eliminate foreign contamination. This is not required for cars with hatch vents.
2. Place resin containment tray below the outlet caps to catch spilled material.
3. Remove the caps from both sides of outlet and secure on cap hangers. The valve cannot be rotated for operation unless both caps are removed. Apply a filter to the nozzle opposite the one used for vacuum connection to eliminate dirt, insect and debris contamination from the surrounding area.

4. To prevent static buildup, connect grounding strap to the hopper car body and the transfer line to ground.
5. Connect pneumatic line to the outlet nozzle using a sliding joint which will allow rotation of the control valve during unloading.
6. Support the pneumatic line adjacent to the nozzle connection to avoid excess friction when the control valve is rotated. If a large, heavy air filter is used on the opposite side, this should be supported also.
7. Avoid sharp bends in transfer hoses.
8. Start the pneumatic system.

Unloading Operations

1. Initially the outlet nozzle will be in the closed position with the center arrow in line with the position indicator.
2. Rotate the control handle. As unloading continues, it is desirable to empty the far side of a railcar compartment or the cab end of a bulk truck first so that vacuum is not lost (because there is no material to block airflow drawn from the compartment or truck body above) before the resin in a given section has been completely consumed.

Clean-Out Operations

1. After the flow of material stops (indicated by a sharp decrease in vacuum), rotate the control handle counterclockwise until material flow starts again. Continue operation until material flow ceases (Figure 10A).
2. Rotate the control handle clockwise until material flow starts. Continue the clockwise rotation until desired material-to-air ratio is achieved. This is best determined by listening for the proper sound of material flow (Figure 10B).
3. When material flow ceases, rotate control handle clockwise a bit further.
4. To complete cleanout, rotate the control handle wide open alternately clockwise and counterclockwise several times, pausing several seconds each time at closed position so vacuum will clear tube.
5. Return control handle to closed position (Figure 10C).

Figure 10
Clean-Out Operations

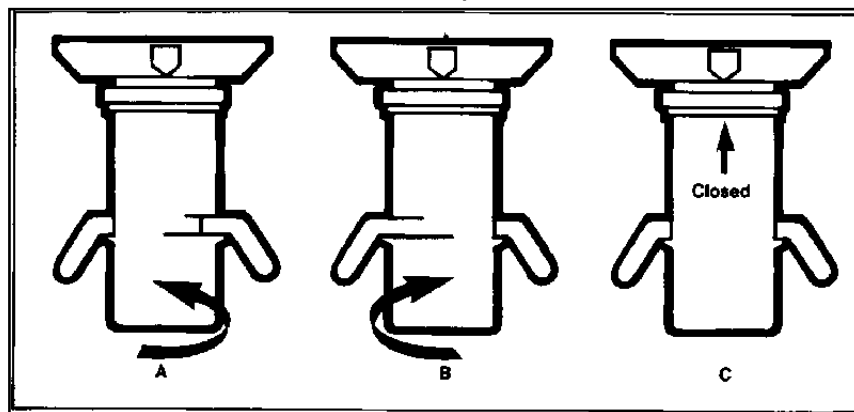

Preparing the Car for Return Transit

1. Shut off vacuum system.
2. Remove hatch filters, check inside of car to see that unloading is complete. Close the hatch and secure in closed position.
3. Disconnect conveying hose from discharge nozzle.
4. Remove the filter on side of car opposite vacuum connection.
5. After making certain that valve is in closed position, apply caps to both discharge nozzles and secure.

Special Note – Interrupted Unloading

If unloading is to be discontinued before the compartment is empty, rotate the end adaptor handles and control valve to the “closed” position. Allow the vacuum system to run for a short period (2 minutes) to clear powder from the bottom of the control valve tube.

Adjustable pneumatic outlets (Figure 11) are designed to provide the following advantages:

1. easy and complete clean-out without disassembly;
2. optimum flow control for all pellets and powders;
3. easier operation because of reduced torque requirements;
4. improved locking device for end cap;
5. new higher strength handles;
6. the provision for product sampling from either side of the outlet.

Figure 11
ACF Adjustable Pneumatic Outlet

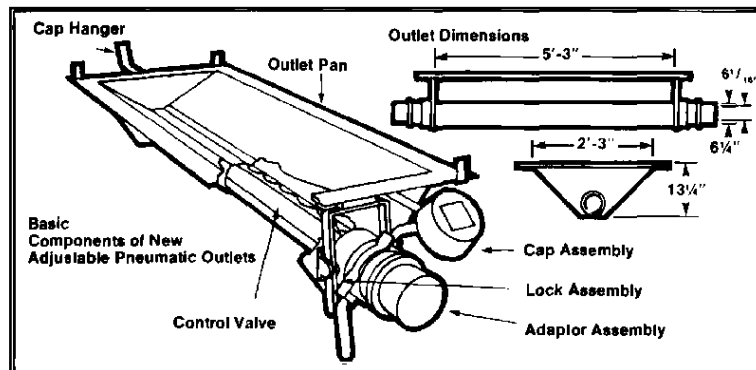

Covered Hopper Car Unloading

Since many bulk commodities tend to compact in transit and may not flow freely at destination, mechanical assistance is sometimes required in unloading hopper cars. Various devices are available that assist unloading while protecting the car itself. Unloading personnel should be familiar with the various methods in order to prevent damage to the cars.

Vibrators

The most commonly used device to assist unloading is the vibrator. It also is the safest if used correctly. However, vibrators can damage the car's structure if improperly used. There are vibrators that are operated by air, electricity, hydraulic drives, or internal combustion engines. Vibrators are fitted into a bracket or shoe found on the car's side slope sheets. There are two types of vibrators in general use: piston and rotary. Because of the manner in which the loads are applied, the car's structure can tolerate a larger force output from the piston type.

In using a vibrator to help unload a Center Flow covered hopper car, the following precautions should be taken:

1. Vibrators should be applied only to the vibrator bracket welded to the outlet slope sheets.
2. They should be used only on the compartment being unloaded and should not be operated continuously – only intermittently to initiate flow.
3. They must be turned off as soon as the compartment is empty. Continued operation may damage the car body since there is no loading to absorb the vibration shock. There are other less commonly used methods of unloading, some of which are not recommended. (See below)

| Table 1 | | | | |
|---------------------------------|------------------------|----------|--------------------|----------|
| Unloading Specifications | | | | |
| Vibrator | Piston Type | | Rotary Type | |
| Operating Frequency | Force in Pounds | | | |
| Revolutions/Minute | A | B | A | B |
| 1000 | 4000 | 3800 | 2400 | 2300 |
| 1500 | 3400 | 3200 | 2150 | 1900 |
| 2000 | 2700 | 2200 | 1700 | 1305 |
| 2400 | 1900 | 1200 | 1200 | 800 |
| 2700 | 1300 | | 800 | |

The Operating frequency and force output must not exceed those listed in Table 1.

- A. Weight of vibrator plus adapter under 65 lbs with maximum operating frequency of 2700 rev/min.
- B. Weight of vibrator plus adapter under 95 lbs with maximum operating frequency of 2400 rev/min.

Pressurization

Because they are not designed to withstand internal pressure, conventional center flow cars cannot be pressurized safely. Pressurization of such cars is strictly prohibited since it is extremely dangerous to the car and operating personnel.

Vacuum Unloading

If a car is being unloaded by a vacuum method, the compartment's hatch must be open or equipped with a vacuum relief device. Otherwise the car could collapse or implode since it cannot withstand negative pressure.



Photo courtesy of Ee-Jay Motor Transports, Inc.

Poling or Air Lancing

Poles or air lances are frequently used by unloaders to dislodge hung-up cargo or assist its flow to the outlet area. (An air lance is metal or plastic pipe with holes through which air is introduced into the cargo to assist the poling operation.) When the poles or air lances are used in lined cars they should be fitted with rubber or plastic tips and extreme care should be exercised to make sure the car's lining is not damaged. If the car is equipped with fluidizing-type outlets, the poles or lances should never touch the fluidizing membranes.

Sledge Hammering

Using a sledge hammer (or any hammer) on the side of a car to help unloading is never recommended. Not only are the effects minimal in speeding up unloading, but it can damage the car's paint finish and interior lining. If it is believed that local hammering really will produce worthwhile results, a rubber mallet should be used carefully.

Car Shakers



Some unloading facilities utilize car shakers, which are powerful devices that are affixed to the top or side of the car. Do not use car shakers since the entire car's structure can be damaged.

Localized Tube Moisture

Unloading issues due to condensation within the compartment can occur. Over time, the excess moisture collects in the bottom valve and tube areas impeding resin flow. Unloading personnel have found that scooping 20 to 35 lbs of saturated resin from the tube allows the dry resin above to transfer normally.



Photo courtesy of Ee-Jay Motor Transports, Inc.

Frozen Tube Moisture

As air temperatures fall below freezing, the condensed moisture described above becomes a larger problem. Under no circumstance should extreme heat be applied to the compartment walls to melt the frozen blockage. Severe damage to both the rail-car's inner liner and to the heat sensitive resin will occur. Instead, either place the rail-car at a location to thaw or contact OxyVinyls for further instructions.

Bulk Trucks

Bulk trucks are unloaded by pressurizing them with a positive displacement blower. The blower is normally part of the truck. These trucks can unload themselves. They blow vinyl resin/powder into a vented silo or receiving bin. Again, ensure the truck and transfer lines are connected to a ground to eliminate static buildup.

Silo Inventory: How Product Weight Can be Calculated

Inventory control requires a close assessment of the amount of resin in a silo at any given time. This can be done with a few simple calculations.

It is important to know three (3) values:

1. Apparent Bulk Density (ABD) of the vinyl resin
2. the silo's internal volume,
3. the product's height within the silo.

ABD is defined as the mass (weight) of the resin divided by the total volume it occupies. Normally it is expressed in g/ml (or cc).

Metric ABD to English Conversion

Example #1: If the ABD of resin or dryblend powder is 0.550 g/ml, then the conversion to English units would be $E = KM$.

Where:

$$\begin{aligned} E &= \text{English units} \\ K &= 62.4 \text{ lbs/ft}^3/\text{g/ml} \\ M &= \text{metric ABD units} = 0.550 \text{ g/ml} \\ E &= (62.4 \text{ lbs/ft}^3/\text{g/ml}) (0.550 \text{ g/ml}) = 34.32 \text{ lbs/ft}^3 \end{aligned}$$

Silo Volume Calculations

The internal volume of a silo is calculated using the following formula: $V = \pi r^2h$.

Where:

$$\begin{aligned} V &= \text{Volume, ft}^3 \\ \pi &= \text{Constant Pi} = 3.14 \\ r &= \text{Radius in ft} \\ h &= \text{Height in ft} \end{aligned}$$

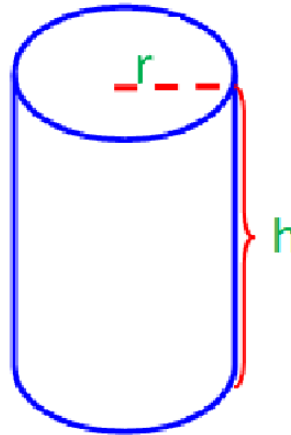

Calculating Total Volume

Example #2: For a silo that is 12 ft in diameter and 56 ft high, the total volume capacity would be as follows:

(Radius is one half the diameter & assumes no conical bottom section.)

$$\begin{aligned} V &= \pi r^2h \\ V &= (3.14) (6 \text{ ft})^2 (56 \text{ ft}) = (3.14) (36 \text{ ft}^2) (56 \text{ ft}) \\ V &= 6330 \text{ ft}^3 \text{ total} \end{aligned}$$

Calculating Partial Volume

Example #3: The volume can be calculated by the measured height of the vinyl resin within the silo. If the vinyl has been measured at 20 ft below the top of the 56 ft high silo, the calculation is:

$$\begin{aligned}V &= \pi r^2(h_1-h_2) \\V &= (3.14) (6 \text{ ft})^2 (56 \text{ ft} - 20 \text{ ft}) = (3.14) (36 \text{ ft}^2) (36 \text{ ft}) \\V &= 4069 \text{ ft}^3\end{aligned}$$

Calculating Bottom Cone Volume

Please note: In both examples #2 & #3, the bottom silo cone volume needs to be added to these calculations with the following formula:

$$V_c = 1/3\pi r^2h$$

V_c = Volume of Cone
 π = Constant Pi = 3.14
 r = Radius in ft
 h = Height in ft

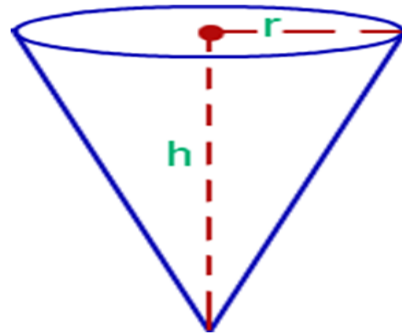

Example #4: Using silo volume and ABD, it is simple to calculate the total capacity of a resin or dryblend powder using the following formula: $P = (ABD) (V)$

Where: P = Pounds of resin
Vinyl ABD = 34.32 lbs/ft³
Silo Volume = 6330 ft³

$$\begin{aligned}P &= (34.32 \text{ lbs/ft}^3) (6330 \text{ ft}^3) \\P &= 217,246 \text{ pounds total}\end{aligned}$$

At minus 20 ft. from the top, the poundage would be:

$$\begin{aligned}P &= (34.32 \text{ lbs/ft}^3) (4069 \text{ ft}^3) \\P &= 139,648 \text{ pounds}\end{aligned}$$

Note: In both cases, cone volume has not been incorporated into the calculation.

The data tables and graph provided in this section shows silo poundage for a range of different ABD materials and silo heights used in our examples. By using these calculations and knowing your raw materials, ABD and silo dimensions, you can now generate your own graph. The more accurate your ABD and your measurement of silo depth, the more accurate your inventory will be.

The calculations assume there is no compaction of the product. A general rule of thumb is compacted ABD of resin will increase the density by 0.10 g/ml or 6.24 lbs/ft³.

If more accuracy is needed, you will need to place a known poundage in your silo. Knowing the volume of the silo, you can calculate the ABD of the material in a full silo with the formula:

$$ABD = P/V.$$

Where: P = Pounds of product
V = Volume of silo

Example #5: If you transfer 180,000 lbs of resin into your 12 ft. diameter silo and it fills 4069 ft³ of volume, then:

$$ABD = 180,000 \text{ lbs} / 4069 \text{ ft}^3$$

$$ABD = 44.23 \text{ lbs/ft}^3$$

This calculation provides the most accurate poundage calculation for your inventory.

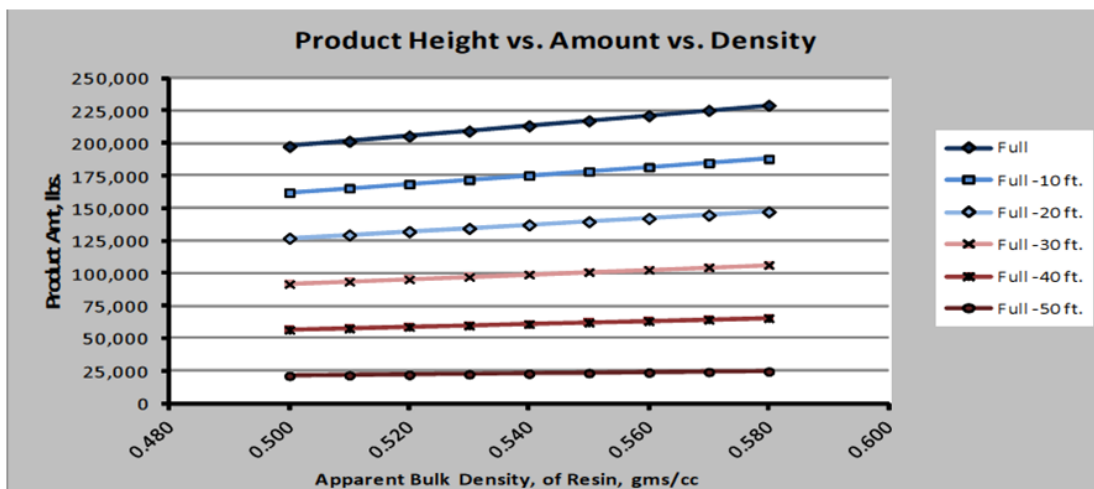

Example: Silo Inventory Data Tables & Graph

Full Silo/Product Height: 56 ft high

Product Height: 46 ft high

| ABD | | Silo Volume | Product Amount | ABD | | Silo Volume | Product Amount |
|------|---------------------|-----------------|----------------|------|---------------------|-----------------|----------------|
| g/ml | lbs/ft ³ | ft ³ | lbs | g/ml | lbs/ft ³ | ft ³ | lbs |
| 0.50 | 31.20 | 6,330 | 197,500 | 0.50 | 31.20 | 5,195 | 162,100 |
| 0.51 | 31.82 | 6,330 | 201,400 | 0.51 | 31.82 | 5,195 | 165,300 |
| 0.52 | 32.45 | 6,330 | 205,400 | 0.52 | 32.45 | 5,195 | 168,600 |
| 0.53 | 33.07 | 6,330 | 209,300 | 0.53 | 33.07 | 5,195 | 171,800 |
| 0.54 | 33.70 | 6,330 | 213,300 | 0.54 | 33.70 | 5,195 | 175,100 |
| 0.55 | 34.32 | 6,330 | 217,300 | 0.55 | 34.32 | 5,195 | 178,300 |
| 0.56 | 34.94 | 6,330 | 221,200 | 0.56 | 34.94 | 5,195 | 181,500 |
| 0.57 | 35.57 | 6,330 | 225,200 | 0.57 | 35.57 | 5,195 | 184,800 |
| 0.58 | 36.19 | 6,330 | 229,100 | 0.58 | 36.19 | 5,195 | 188,000 |

Product Height: 36 ft high

| ABD | | Silo Volume | Product Amount |
|------|---------------------|-----------------|----------------|
| g/ml | lbs/ft ³ | ft ³ | lbs |
| 0.50 | 31.20 | 4,069 | 127,000 |
| 0.51 | 31.82 | 4,069 | 129,500 |
| 0.52 | 32.45 | 4,069 | 132,100 |
| 0.53 | 33.07 | 4,069 | 134,600 |
| 0.54 | 33.70 | 4,069 | 137,100 |
| 0.55 | 34.32 | 4,069 | 139,700 |
| 0.56 | 34.94 | 4,069 | 142,200 |
| 0.57 | 35.57 | 4,069 | 144,800 |
| 0.58 | 36.19 | 4,069 | 147,300 |

Product Height: 26 ft high

| ABD | | Silo Volume | Product Amount |
|------|---------------------|-----------------|----------------|
| g/ml | lbs/ft ³ | ft ³ | lbs |
| 0.50 | 31.20 | 2,939 | 91,700 |
| 0.51 | 31.82 | 2,939 | 93,500 |
| 0.52 | 32.45 | 2,939 | 95,400 |
| 0.53 | 33.07 | 2,939 | 97,200 |
| 0.54 | 33.70 | 2,939 | 99,100 |
| 0.55 | 34.32 | 2,939 | 100,900 |
| 0.56 | 34.94 | 2,939 | 102,700 |
| 0.57 | 35.57 | 2,939 | 104,500 |
| 0.58 | 36.19 | 2,939 | 106,400 |

Product Height: 16 ft high

| ABD | | Silo Volume | Product Amount |
|------|---------------------|-----------------|----------------|
| g/ml | lbs/ft ³ | ft ³ | lbs |
| 0.50 | 31.20 | 1,809 | 56,400 |
| 0.51 | 31.82 | 1,809 | 57,600 |
| 0.52 | 32.45 | 1,809 | 58,700 |
| 0.53 | 33.07 | 1,809 | 59,800 |
| 0.54 | 33.70 | 1,809 | 60,900 |
| 0.55 | 34.32 | 1,809 | 62,100 |
| 0.56 | 34.94 | 1,809 | 63,200 |
| 0.57 | 35.57 | 1,809 | 64,300 |
| 0.58 | 36.19 | 1,809 | 65,500 |

Product Height: 6 ft high

| ABD | | Silo Volume | Product Amount |
|------|---------------------|-----------------|----------------|
| g/ml | lbs/ft ³ | ft ³ | lbs |
| 0.50 | 31.20 | 678 | 21,200 |
| 0.51 | 31.82 | 678 | 21,600 |
| 0.52 | 32.45 | 678 | 22,000 |
| 0.53 | 33.07 | 678 | 22,400 |
| 0.54 | 33.70 | 678 | 22,900 |
| 0.55 | 34.32 | 678 | 23,300 |
| 0.56 | 34.94 | 678 | 23,700 |
| 0.57 | 35.57 | 678 | 24,100 |
| 0.58 | 36.19 | 678 | 24,600 |





Oxy Vinyls, LP

A subsidiary of Occidental Petroleum Corporation

OxyVinyls

Headquarters

14555 Dallas Pkwy, Suite 400
Dallas, Texas 75254
(877) 699-8465 (toll free)
www.oxychem.com

Emergency Numbers

Normal business hours : (877) 699-8465
After hours emergency : (888) 434-9779

Sales

sales@oxyvinyls.com

Customer Service/ Technical Service

(877) 699-8465 (toll free)
Customer_service_oxychem@oxy.com

The Vinyl Institute

<http://vinylinfo.org/>
(571) 970-3400